



香港
建造
學院 | HONG KONG
INSTITUTE
OF
CONSTRUCTION

Safety Training Course for Construction Workers of Specified Trade (Silver Card Course)

Rigger (A12) Key Points Review (M1)

4.2020





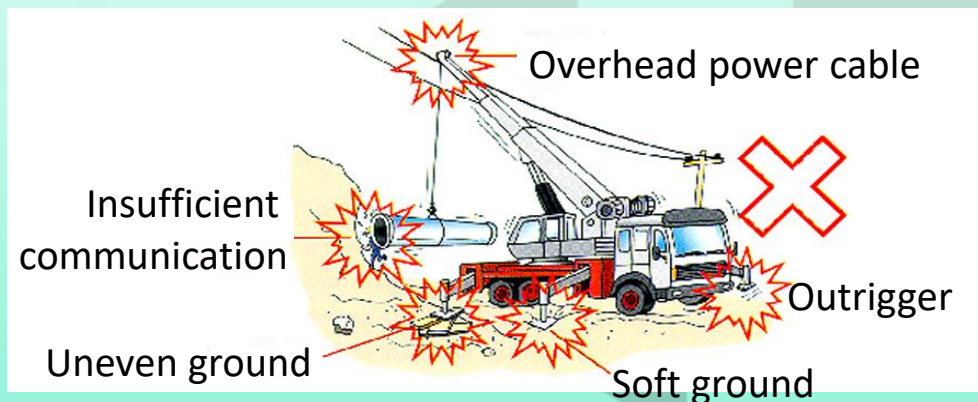

I. Common Accidents and Causes of Lifting Operation

- Incorrect lifting processes can lead to very serious accidents.
- There have been many accidents about lifting in the past, such as crane collapse, sling break, sling sledding causing material to fall, overweight causing the boom to break, contact with overhead power cable etc..
- There are a number of factors involved, including human, machines, load, method and the environment.
- Among these factors lies an important relationship, so must ensure that all factors are controlled before the lifting process can be carried out safely.

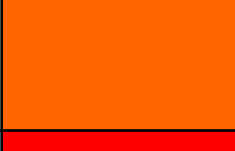
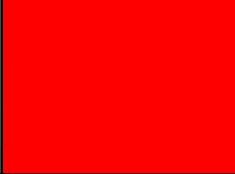

II. Color Marking System for lifting tools (Government Site)

Jan – Mar	BLUE	
Apr – Jun	YELLOW	
Jul – Sep	GREEN	
Oct – Dec	ORANGE	
to be removed from the site	RED	
Equipment awaiting for inspection	WHITE	

III. Basic Lifting Safety Measures

1. Recognize the categories and construction of lifting tools.
2. Personal protective equipment (e.g. safety helmets, safety shoes, protective gloves) should be worn prior to work on daily basis.
3. It is important to be aware of the “Safe Working Load” (SWL) of lifting appliance and lifting gears.
4. Before lifting, know the weight of the load in order to select the appropriate lifting gear.
5. The slinger shall ensure that the sling used has a valid examination certificate and is engraved with the sling number.

III. Basic Lifting Safety Measures

6. Check whether the crane hook is equipped with an insurance or steel rope hook insurance, so as to ensure its safe working order.
7. Loose materials should be properly placed in a suitable receptacle after passing the inspection (the carrier should have been inspected and engraved with a safe operating load SWL).
8. Pay attention to the weight of the load to maintain balance, then ensure that the weight is evenly distributed, and avoid one side of the sling to withstand excessive load force.
9. When using two pairs of slings, the angle between the slings must not exceed 90° .
10. Do not stand under the boom or under load and within the swing range when lifting.

III. Basic Lifting Safety Measures

11. Pay attention to whether the lifting material stacking area is safe.
12. When hanging a sling or a sling is attached, use a shackle or ring with a valid certificate.
13. Have sufficient knowledge to know the angle of the sling and the sling chain in use, as the crane will change the load force accordingly (see sling chain, sling angle and load chart). The angle of the sling and the sling should not be greater than 120° (preferably within 90°). Other tools (e.g. gantry hangers) can be used if required.
14. Do not use webbing slings when lifting with a sharp edged objects.

III. Basic Lifting Safety Measures

15. When lifting a long object, avoid the use of a single sling. Should attach two sides with a tail rope, free of suspension swing, instead of with a crane to pull (drag) the load.
16. Implementation of lifting 3-3-3 (i.e. to lift the load at 300mm above ground for 3 seconds and others stay away from 3m).
17. When handling a crane that is prone to wear ropes, be protected with a protective pad.
18. Slings in a spiral twisting state should not be used.
19. Do not throw lifting tools and slings at height.
20. Prior to unloading the lifting tools and slings, pay attention to whether the load is static and stable.

III. Basic Lifting Safety Measures

21. Before removal and installation, the contingency method in the event of a hazardous situation should be considered in advance.
22. The safety of the crane/heavy object from its own distance should always be taken into account at the site. Do not stand in the DEAD area during lifting. Make sure that others stay away from the lifting zone.
23. The lifting gear after use must be stored properly.

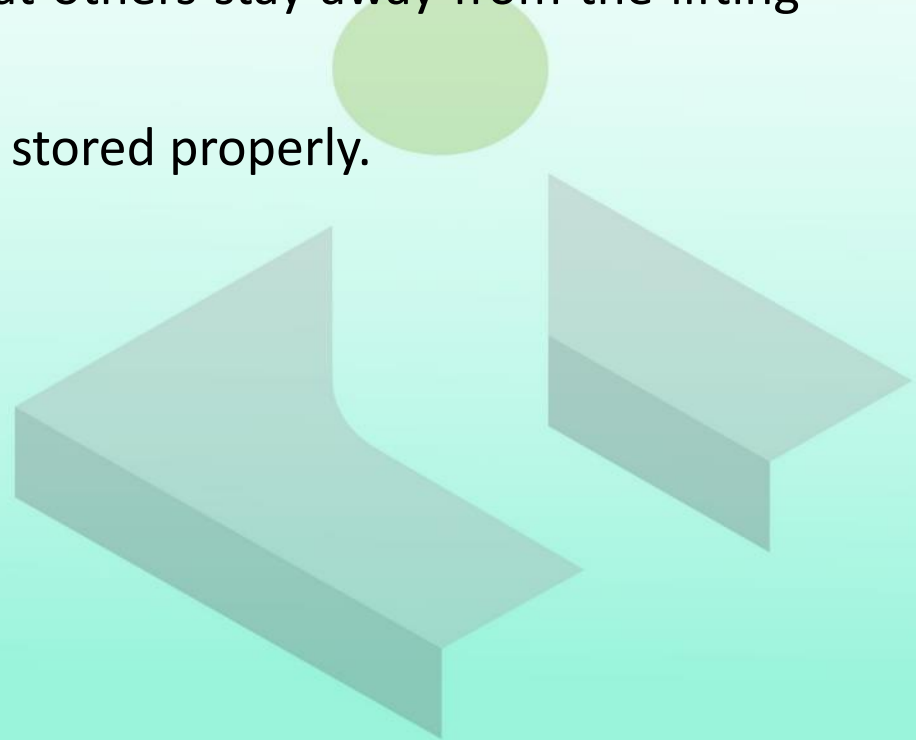

Angle vs loading

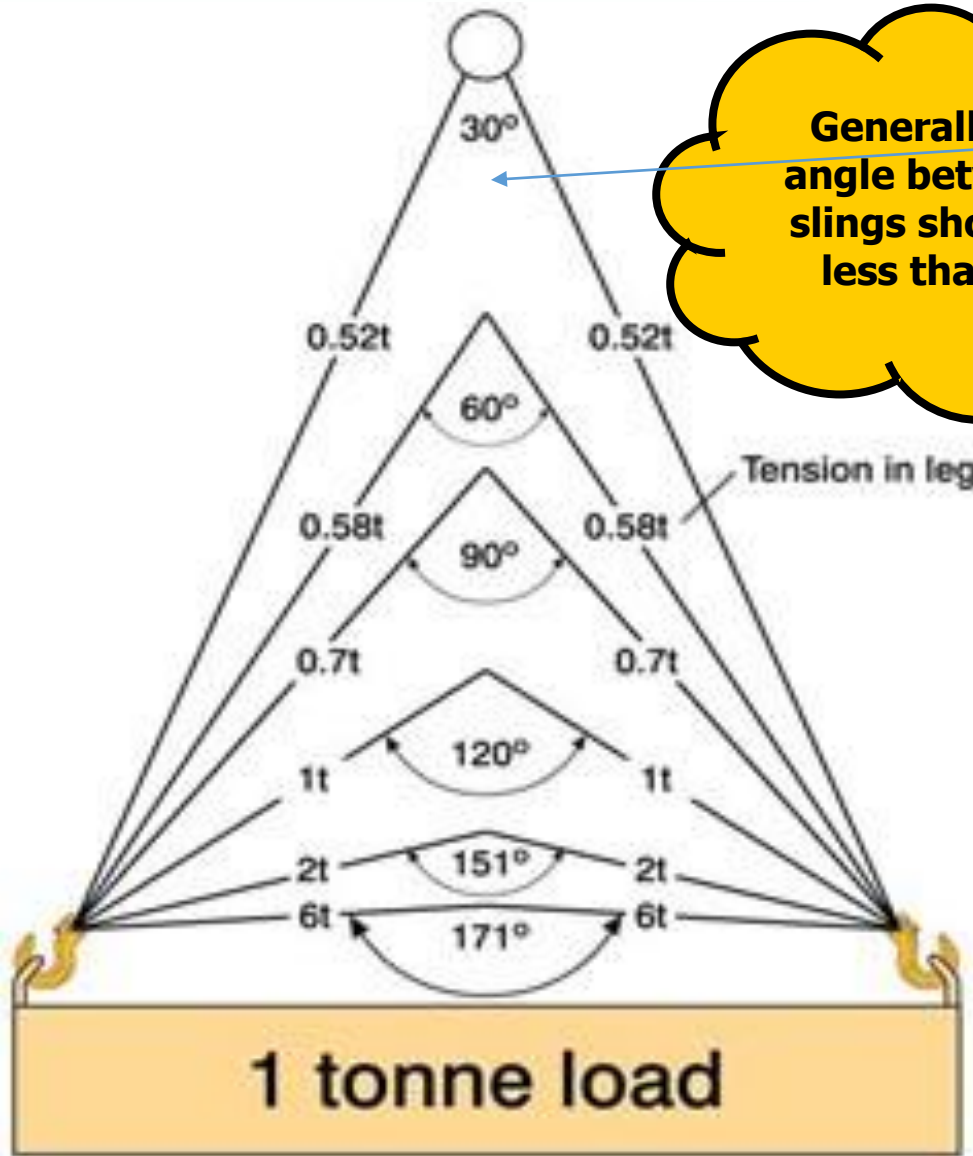

Generally, the angle between 2 slings should be less than 90°

If angle increases, lifting capacity will decrease

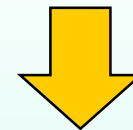

Tension of each slings will increase



Finally, lifting capacity will decrease

Common Site Practice/Special Lifting Method

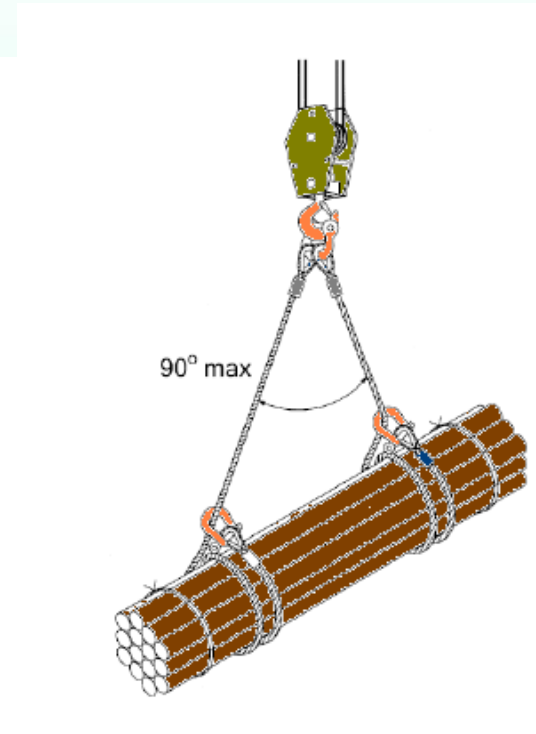
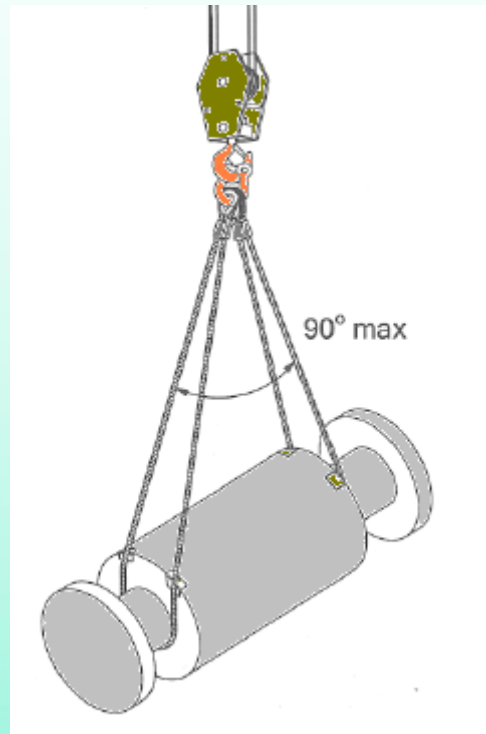
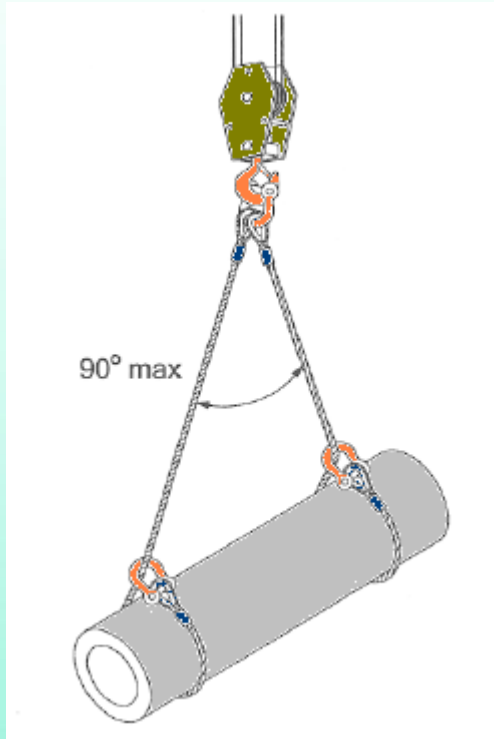

Copyright and Republication

All contents and information, including but not limited to graphical design, are proprietary to The Hong Kong Institute of Construction and are subjected to copyright protection. Republication, redistribution or unauthorized use of any content or information contained in this document is expressly prohibited without the prior written consent of The Hong Kong Institute of Construction.

Disclaimer

Although the author and publisher believe that the information and guidelines contained in this document are correct, any person using this document must rely on his/her own skills and judgement. The author or the publisher will not be liable for any loss or damage arising from any omissions in this document (whether in negligence or otherwise).